



AANBOD
VERHUUR

BECONA
BEKISTINGSTECHNOLOGIE

STABIEL | FLEXIBEL | EENVOUDIG | VEILIG | VOORDELIG

BECONA DOET BETER!

De huidige bekistingssystemen zijn op 20 jaar tijd weinig geëvolueerd. Het is één van de zeldzame deelsectoren in de bouw die nauwelijks kennis heeft gemaakt met innovatieve vernieuwing. De dagelijkse praktijk leert dat de bekistingen van tegenwoordig regelmatig irritaties opwekken: ze buigen door, zijn niet flexibel te monteren, enzovoort.

Precies om deze reden heeft BECONA een eigen, **gloednieuw en revolutionair systeem van bekistingen** ontwikkeld. De beplating die hiervoor gebruikt wordt, is niet langer uit hout, maar **uit kunststof**. Dit zorgt voor een zeer glad betonoppervlak omwille van de speciale coating.

BECONA biedt een brede waaier van producten om zowel grote als kleine projecten te kunnen bedienen, die allen gebaseerd zijn op de **nieuwe, zelf ontwikkelde bekistingstechnologie**.

Als aannemer of particulier kan u steeds bij ons terecht voor de **huur en/of aankoop van uw systeembekisting, maatwerk en verbruiksgoederen**. Dankzij ons flexibel team, onze kunststofbeplating van **Alkus** en ons uitgekiend systeem garanderen wij een unieke kwaliteit en service.

PRIMUS

Wand-, kolom- en balkbekistingen uit aluminium. Voorzien van Alkus kunststofbeplating.

ROTONDUS

Circulaire bekistingen, die zowel hol als bol eenvoudig instelbaar zijn.

ROBUSTUS

Verrijdbare batterijbekistingen (Maatwerk).

KUNSTSTOFBEPLATING: ALKUS

BECONA biedt ALKUS kunststofbeplating aan in verkoop.

VERBRUIKSGOEDEREN

BECONA heeft een ruim assortiment van allerlei benodigheden om plaatsing, gebruik en onderhoud van uw bekisting te vergemakkelijken.

REINIGINGS- EN REPARATIESERVICE

BECONA beschikt over een automatische wasstraat waardoor het mogelijk is uw aangekochte panelen, ongeacht welk materiaal en merk, te laten reinigen. Systeembekisting met kunststofplaten kan in onze werkplaats hersteld worden.

HOE TERUGBRENGEN?



PANELEN



A



C



D



B

- A Kolompaneel
- B Aanlegpaneel
- C Wandpaneel
- D Variabele kopafsluiting
- E Binnenhoek
- F Kolombinnenhoek
- G Buitenhoekprofiel
- H Ontkistingshoek



E



F



G



H

PANELEN HOOGTE 3000 mm

PRIMUS KOLOMPANELEN

- KU 130 912 3000x1200 Kunststof (130 kg)
- KU 130 990 3000x900 Kunststof (105 kg)

PRIMUS WANDPANELEN

- KU 130 822 3000x2200 Kunststof (235 kg)
- KU 130 812 3000x1200 Kunststof (120 kg)
- KU 130 890 3000x900 Kunststof (95 kg)
- KU 130 830 3000x300 Kunststof (50 kg)

PRIMUS AANLEGPANELEN

- KU 130 575 3000x750 Kunststof (85 kg)
- KU 130 570 3000x700 Kunststof (80 kg)
- KU 130 565 3000x650 Kunststof (75 kg)
- KU 130 560 3000x600 Kunststof (75 kg)
- KU 130 555 3000x550 Kunststof (70 kg)
- KU 130 550 3000x500 Kunststof (65 kg)
- KU 130 545 3000x450 Kunststof (60 kg)

VARIABELE KOPAFSLUITING

- KU 130 110 Variabele kopafsluiting 3000 (16 kg)

PRIMUS [KOLOM]BINNENHOEKEN

- KU 130 630 Binnenhoek 3000x300x300 Kunststof (70 kg)
- KU 130 660 Kolombinnenhoek 3000x300x600 Kunststof (95 kg)

PRIMUS BUITENHOEKPROFIELEN

- KU 130 190 3000 - 90° (30 kg)

MAGNUS VARIABELE HOEKEN

- KU 230 330 Binnenhoek 3000x300x300 (135 kg)
- KU 230 243 Buitenhoek 3000x435x435 (185 kg)

MAGNUS ONTKISTINGSHOEKEN

- KU 230 430 3000x300x300 (180 kg)

PANELEN HOOGTE 2700 mm

PRIMUS KOLOMPANELEN

- KU 127 912 2700x1200 Kunststof (120 kg)
- KU 127 990 2700x900 Kunststof (95 kg)

PRIMUS WANDPANELEN

- KU 127 822 2700x2200 Kunststof (210 kg)
- KU 127 812 2700x1200 Kunststof (110 kg)
- KU 127 890 2700x900 Kunststof (85 kg)
- KU 127 830 2700x300 Kunststof (45 kg)

PRIMUS AANLEGPANELEN

- KU 127 575 2700x750 Kunststof (80 kg)
- KU 127 570 2700x700 Kunststof (75 kg)
- KU 127 565 2700x650 Kunststof (70 kg)
- KU 127 560 2700x600 Kunststof (65 kg)
- KU 127 555 2700x550 Kunststof (65 kg)
- KU 127 550 2700x500 Kunststof (60 kg)
- KU 127 545 2700x450 Kunststof (55 kg)

VARIABELE KOPAFSLUITING

- KU 127 110 Variabele kopafsluiting 2700 (14 kg)

PRIMUS [KOLOM]BINNENHOEKEN

- KU 127 630 Binnenhoek 2700x300x300 Kunststof (65 kg)
- KU 127 660 Kolombinnenhoek 2700x300x600 Kunststof (90 kg)

PRIMUS BUITENHOEKPROFIELEN

- KU 127 190 2700 - 90° (25 kg)

MAGNUS VARIABELE HOEKEN

- KU 227 330 Binnenhoek 2700x300x300 (125 kg)
- KU 227 243 Buitenhoek 2700x435x435 (170 kg)

MAGNUS ONTKISTINGSHOEKEN

- KU 227 430 2700x300x300 (165 kg)

PANELEN



A



C



D



B

- A Kolompaneel
- B Aanlegpaneel
- C Wandpaneel
- D Variabele kopafsluiting
- E Binnenhoek
- F Kolombinnenhoek
- G Buitenhoekprofiel
- H Ontkistingshoek



E



F



G



H

PANELEN HOOGTE 1500 mm

PRIMUS KOLOMPANELEN

- KU 115 912 1500x1200 Kunststof (75 kg)
- KU 115 990 1500x900 Kunststof (60 kg)

PRIMUS WANDPANELEN

- KU 115 812 1500x1200 Kunststof (65 kg)
- KU 115 890 1500x900 Kunststof (50 kg)
- KU 115 830 1500x300 Kunststof (25 kg)

PRIMUS AANLEGPANELEN

- KU 115 575 1500x750 Kunststof (45 kg)
- KU 115 570 1500x700 Kunststof (45 kg)
- KU 115 565 1500x650 Kunststof (40 kg)
- KU 115 560 1500x600 Kunststof (40 kg)
- KU 115 555 1500x550 Kunststof (35 kg)
- KU 115 550 1500x500 Kunststof (35 kg)
- KU 115 545 1500x450 Kunststof (30 kg)

PRIMUS [KOLOM]BINNENHOEKEN

- KU 115 630 Binnenhoek 1500x300x300 Kunststof (35 kg)
- KU 115 660 Kolombinnenhoek 1500x300x600 Kunststof (60 kg)

PRIMUS BUITENHOEKPROFIELEN

- KU 115 190 1500 - 90° (15 kg)

MAGNUS VARIABELE HOEKEN

- KU 215 330 Binnenhoek 1500x300x300 (70 kg)
- KU 215 243 Buitenhoek 1500x435x435 (100 kg)

MAGNUS ONTKISTINGSHOEKEN

- KU 215 430 1500x300x300 (90 kg)

PANELEN HOOGTE 1200 mm

PRIMUS KOLOMPANELEN

- KU 112 912 1200x1200 Kunststof (60 kg)
- KU 112 990 1200x900 Kunststof (50 kg)

PRIMUS WANDPANELEN

- KU 112 812 1200x1200 Kunststof (55 kg)
- KU 112 890 1200x900 Kunststof (45 kg)
- KU 112 830 1200x300 Kunststof (20 kg)

PRIMUS AANLEGPANELEN

- KU 112 575 1200x750 Kunststof (40 kg)
- KU 112 570 1200x700 Kunststof (35 kg)
- KU 112 565 1200x650 Kunststof (35 kg)
- KU 112 560 1200x600 Kunststof (35 kg)
- KU 112 555 1200x550 Kunststof (30 kg)
- KU 112 550 1200x500 Kunststof (30 kg)
- KU 112 545 1200x450 Kunststof (30 kg)

PRIMUS [KOLOM]BINNENHOEKEN

- KU 112 630 Binnenhoek 1200x300x300 Kunststof (30 kg)
- KU 112 660 Kolombinnenhoek 1200x300x600 Kunststof (55 kg)

PRIMUS BUITENHOEKPROFIELEN

- KU 112 190 1200 - 90° (13 kg)

MAGNUS VARIABELE HOEKEN

- KU 212 330 Binnenhoek 1200x300x300 (55 kg)
- KU 212 243 Buitenhoek 1200x435x435 (85 kg)

MAGNUS ONTKISTINGSHOEKEN

- KU 212 430 1200x300x300 (75 kg)

ROTONDUS PANELEN

WANDPANELEN HOOGTE 2700 mm

- KU 327 818 2700x1800 Kunststof (170 kg)
- KU 327 890 2700x900 Kunststof (95 kg)

WANDPANELEN HOOGTE 1650 mm

- KU 316 818 1650x1800 Kunststof (100 kg)
- KU 316 890 1650x900 Kunststof (60 kg)



TOEBEHOREN ROTONDUS



- **MB 077 003**
Kraanhaak Rotondus (9,2 kg)
 - Max Toegelaten Hefvermogen = 1000 kg
 - Gekeurd
-



- **MB 077 004**
Tondeur Rotondus (3,5 kg)
 - 1x Basis Tondeur Rotondus
 - 2x R-Pen 3-3.5 mm Dubbel (G 340 001)
 - 2x Blokkeerpen Ø25-18 L=107 mm (G 520 016)
-



- **MB 077 005**
Scharnierstuk Rotondus (15,6 kg)
 - 1x Basis Scharnierstuk Rotondus
 - 2x R-Pen 3-3.5 mm Dubbel (G 340 001)
 - 2x Blokkeerpen Ø25-18 L=120 mm (G 520 017)
-



- **TK 010 004**
Materiaalbak Becona Rotondus (400 kg gevuld)

Volledig gevuld goed voor één van volgende mogelijkheden:

 - 4x KU 327 818
 - 4x KU 316 818
 - 8x KU 327 890
 - 8x KU 316 890

TOEBEHOREN



- **MB 073 001**
Spanklem (3 kg)
 - Max Klemafstand = 130 mm
 - Max Openstand = 145 mm
-

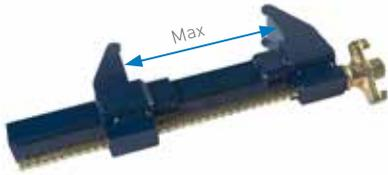

- **BK 073 002**
Variabele Spanklem (5,3 kg)
 - Max = 320 mm
 - **BK 073 003**
Verlengde Variabele Spanklem (7,1 kg)
 - Max = 650 mm
-

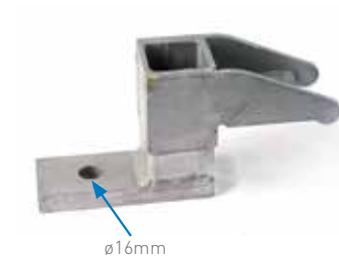

- **MB 073 004**
Voetklem (2,2 kg)
-



- **MB 073 100**
Klemkop (1,9 kg)
-

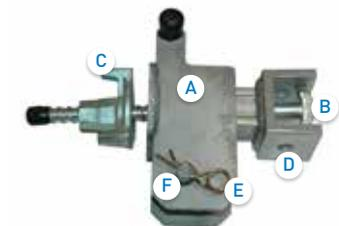

- **MB 073 101**
Klemkop Set (3,6 kg)
 - A** 1x Klemkop (MB 073 100)
 - B** 1x Hamerkopbout (MB 074 004)
 - C** 1x Vleugelmoer $\varnothing 70 - 15F$ (MB 085 611)
 - D** 1x Uniblok (G 900 001)
 - E** 1x R-Pen 3-3.5 mm Dubbel (G 340 001)
 - F** 1x Blokkeerpen $\varnothing 25-15 L=102$ mm (G 520 001)
-



- **MB 073 200**
Klemafstandhouder (2,5 kg)

TOEBEHOREN

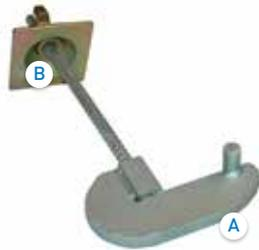

- **MB 073 601**

Klemanker Set L=410 (3,9 kg)

- **A** 1x Klemanker L=410 (MB 073 604)
- **B** 1x Vleugelmoer met Oplegplaat 120x120 - 15F (MB 085 613)



- **MB 073 602**

Klemanker L=410 (2,8 kg)

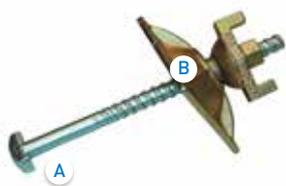

- **MB 074 001**

Ankerset (1,6 kg)

- **A** 1x Hamerkopbout (MB 074 004)
- **B** 1x Vleugelmoer met Oplegplaat 120x120 - 15F (MB 085 613)

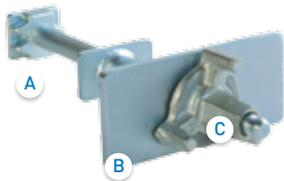

- **MB 074 002**

Hoekankerset (3 kg)

- **A** 1x Instelnaaf (MB 074 003)
- **B** 1x Drukplaat - 15F (MB 075 002)
- **C** 1x Vleugelmoer $\varnothing 70$ - 15F (MB 085 611)



- **MB 074 003**

Instelnaaf (1 kg)



- **MB 074 004**

Hamerkopbout (0,6 kg)

TOEBEHOREN



- **MB 074 005**
Holle Instelnaaf – Variabele kopafsluiting (0,6 kg)
-

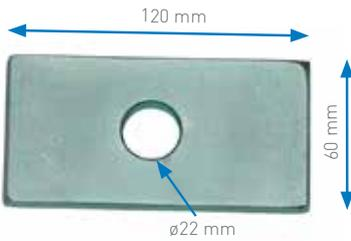

- **MB 075 001**
Stalen Oplegplaat (0,6 kg)
-



- **MB 075 002**
Drukplaat (1,5 kg)
-



- **MB 075 003**
Verstevigde Drukplaat (1,65 kg)
-



- **MB 075 004**
Blindplaat Klein - 20F (3,3 kg) **A**
 - **MB 075 005**
Blindplaat Groot - 20F (3,7 kg) **B**
-



- **MB 075 006**
Sluitplaat – Variabele kopafsluiting (0,8 kg)

TOEBEHOREN



- **CENTERSTAAF**
 - **MB 085 511**
L=300 mm - 15F (0,43 kg)
 - **MB 085 512**
L=470 mm - 15F (0,67 kg)
 - **MB 085 513**
L=800 mm - 15F (1,14 kg)
 - **MB 085 514**
L=1000 mm - 15F (1,43 kg)
 - **MB 085 515**
L=1200 mm - 15F (1,72 kg)
- **MB 085 561**
L=800 mm - 20F (2,05 kg)
- **MB 085 562**
L=1000 mm - 20F (2,56 kg)
- **MB 085 563**
L=1200 mm - 20F (3,07 kg)



- **MB 085 611**
Vleugelmoer \varnothing 70 - 15F (0,5 kg)



- **MB 085 613**
Vleugelmoer met Oplegplaat 120x120 - 15F (1,2 kg)



- **MB 085 615**
Zeskantmoer L=50 mm - 15F (0,22 kg)
- **MB 085 662**
Zeskantmoer L=70 mm - 20F (0,40 kg)



- **MB 085 617**
Verbindingsmoer L=105 mm - 15F (0,44 kg)
- **MB 085 663**
Verbindingsmoer L=130 mm - 20F (0,74 kg)

TOEBEHOREN



- **MB 085 661**
Vleugelmoer met Oplegplaat \varnothing 130 - 20F (1,3 kg)
-



- **G 900 001**
Uniblok (0,4 kg)
-



- **G 340 001**
R-Pen 3-3.5 mm Dubbel
-



- **G 520 001**
Blokkeerpen \varnothing 25-15 L=102 mm (0,16 kg)
 - **G 520 014**
Blokkeerpen \varnothing 20-12 L=110 mm (0,13 kg)
-



- **G 520 016**
Blokkeerpen \varnothing 25-18 L=107 mm (0,16 kg)
- **G 520 017**
Blokkeerpen \varnothing 25-18 L=120 mm (0,18 kg)

RICHTSCHOREN

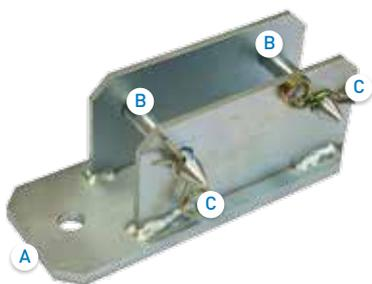

- **MB 072 013**

Richtschoorvoet Dubbel Set (3 kg)

- **A** 1x Richtschoorvoet Dubbel (MB 072 019)
- **B** 2x Blokkeerpen Ø25-15 L=102 mm (G 520 001)
- **C** 2x R-Pen 3-3.5 mm Dubbel (G 340 001)

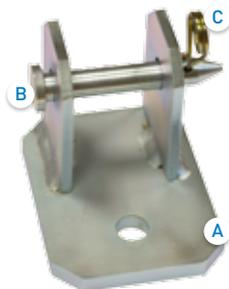

- **MB 072 014**

Richtschoorvoet Enkel Set (1,3 kg)

- **A** 1x Richtschoorvoet Enkel (MB 072 020)
- **B** 1x Blokkeerpen Ø25-15 L=102 mm (G 520 001)
- **C** 1x R-Pen 3-3.5 mm Dubbel (G 340 001)



- **MB 072 015**

Spindel + Moer Links (3,2 kg)

- **MB 072 016**

Spindel + Moer Rechts (3,2 kg)



- **MB 072 017**

Buis L=700 mm (5.9 kg)

- **MB 072 018**

Buis L=1585 mm (11.1 kg)



- **MB 072 019**

Richtschoorvoet Dubbel (2,7 kg)

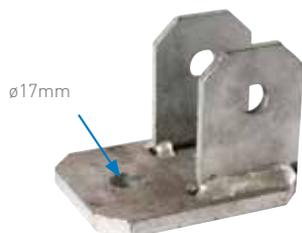

- **MB 072 020**

Richtschoorvoet Enkel (1,2 kg)

RICHTSCHOREN



- **MB 072 101**

Dubbele Richtschoor 2700-3000 (40 kg)

- Ⓐ 1x Buis L=700 mm (MB 072 017)
- Ⓑ 1x Buis L=1585 mm (MB 072 018)
- Ⓒ 1x Richtschoorvoet Dubbel Set (MB 072 013)
- Ⓓ 2x Spindel + Moer Links (MB 072 015)
- Ⓔ 2x Spindel + Moer Rechts (MB 072 016)
- Ⓕ 2x Klemkop Set (MB 073 101)



- **MB 072 102**

Enkele Richtschoor 2700-3000 (24 kg)

- Ⓐ 1x Buis L=1585 mm (MB 072 018)
- Ⓑ 1x Richtschoorvoet Enkel Set (MB 072 014)
- Ⓒ 1x Spindel + Moer Links (MB 072 015)
- Ⓓ 1x Spindel + Moer Rechts (MB 072 016)
- Ⓔ 1x Klemkop Set (MB 073 101)

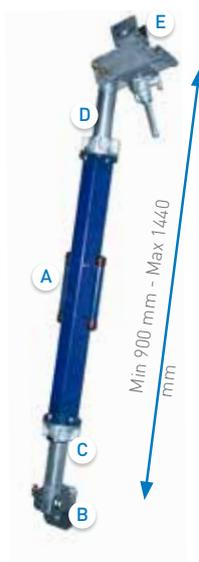

- **MB 072 103**

Enkele Richtschoor 1500 (17 kg)

- Ⓐ 1x Buis L=700 mm (MB 072 017)
- Ⓑ 1x Richtschoorvoet Enkel Set (MB 072 014)
- Ⓒ 1x Spindel + Moer Links (MB 072 015)
- Ⓓ 1x Spindel + Moer Rechts (MB 072 016)
- Ⓔ 1x Klemkop Set (MB 073 101)

RICHTSCHOREN

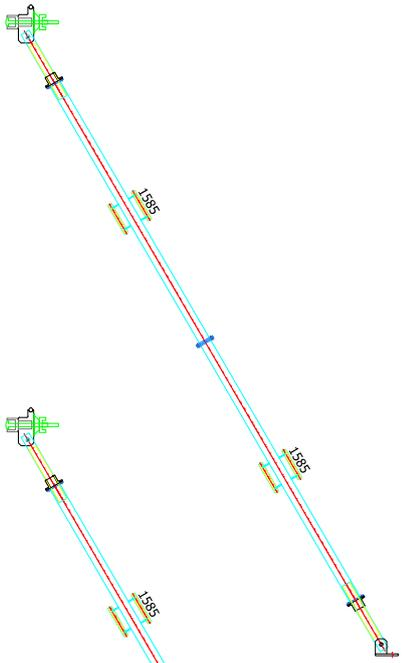

- **MB 072 105**

Verlengde Enkele Richtschoor (1585-1585) (34 kg)

- 2x Buis L=1585 mm (MB 072 018)
- 1x Richtschoorvoet Enkel Set (MB 072 014)
- 1x Spindel + Moer Links (MB 072 015)
- 1x Spindel + Moer Rechts (MB 072 016)
- 1x Klemkop Set (MB 073 101)

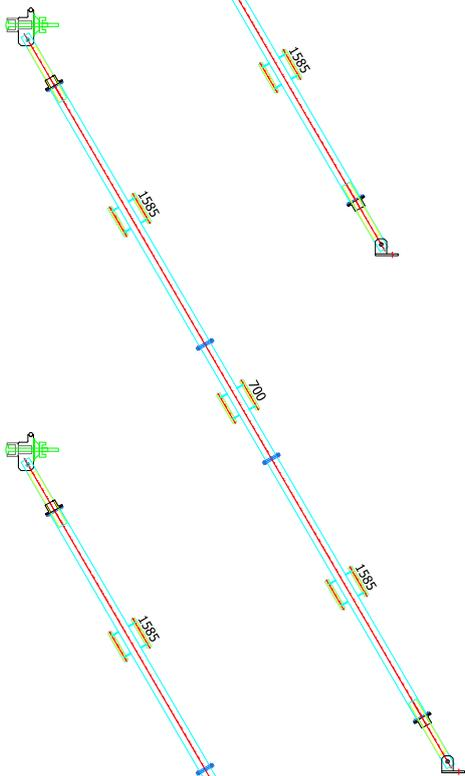

- **MB 072 106**

Verlengde Enkele Richtschoor +700 (1585-700-1585) (40 kg)

- 2x Buis L=1585 mm (MB 072 018)
- 1x Buis L=700 mm (MB 072 017)
- 1x Richtschoorvoet Enkel Set (MB 072 014)
- 1x Spindel + Moer Links (MB 072 015)
- 1x Spindel + Moer Rechts (MB 072 016)
- 1x Klemkop Set (MB 073 101)

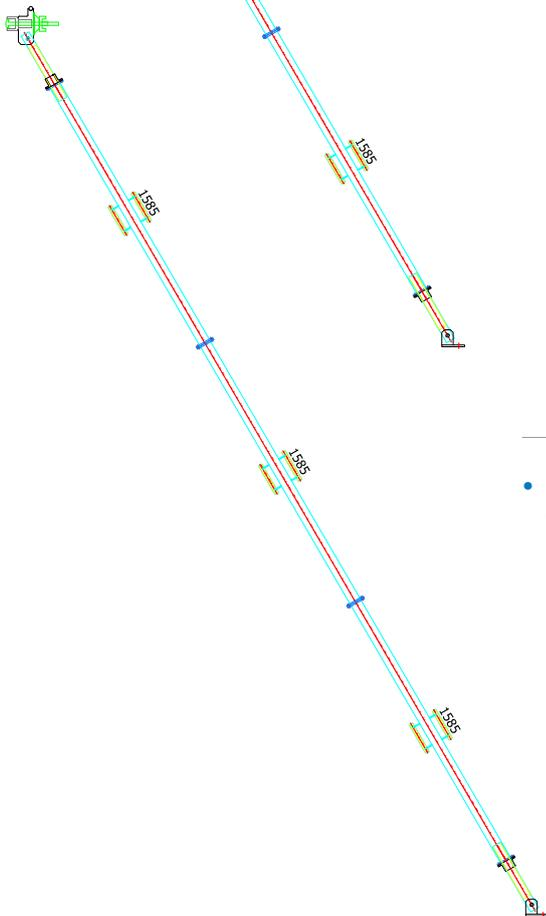

- **MB 072 107**

Verlengde Enkele Richtschoor +1585 (1585-1585-1585) (45 kg)

- 3x Buis L=1585 mm (MB 072 018)
- 1x Richtschoorvoet Enkel Set (MB 072 014)
- 1x Spindel + Moer Links (MB 072 015)
- 1x Spindel + Moer Rechts (MB 072 016)
- 1x Klemkop Set (MB 073 101)

HULPMIDDELEN

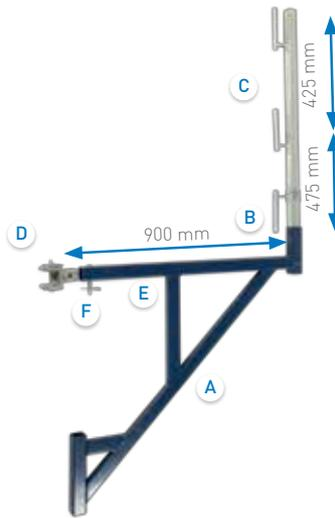

- **MB 077 000**
Werfkar (62,8 kg)

- **MB 077 001**
Loopconsole (14,1 kg)

- **A** Onderstel Loopconsole (W 900 018 8B)
- **B** Hulpstuk Plint (W 900 020 8B)
- **C** Borstwering (W 900 019 8B)
- **D** 1x Uniblok (G 900 001)
- **E** 2x R-Pen 3-3.5 mm Dubbel (G 340 001)
- **F** 2x Blokkeerpen \varnothing 20-12 L=110 mm (G 520 014)

- **MB 077 002**
Kraanhaak (9,3 kg)

- Max Toegelaten Hefvermogen = 1000 kg
- Gekeurd

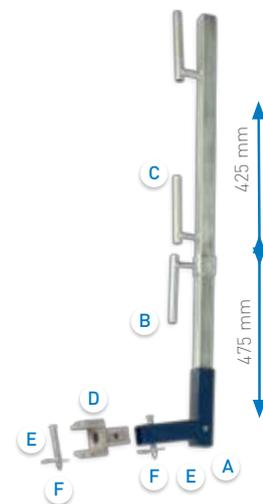
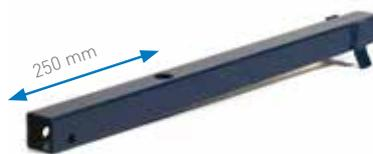
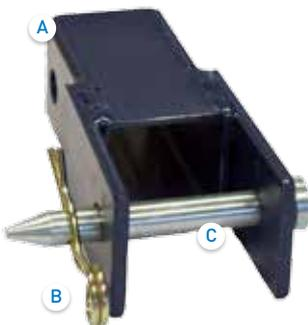

- **MB 077 006**
Hulpstuk Kopse Valbeveiliging (0,8 kg)

- **A** Basis Hulpstuk Kopse Valbeveiliging (W 077 006 8B)
- **B** 1x R-Pen 3-3.5 mm Dubbel (G 340 001)
- **C** 1x Blokkeerpen \varnothing 20-12 L=110 mm (G 520 014)

- **MB 077 007**
Hulpstuk Loopconsole (3,6 kg)

- **MB 077 008**
Valbeveiliging (5,5 kg)

- **A** Onderstel Valbeveiliging (W 0900 023 8B)
- **B** Hulpstuk Plint (W 0900 020 8B)
- **C** Borstwering (W 0900 019 8B)
- **D** 1x Uniblok (G 900 001)
- **E** 2x R-Pen 3-3.5 mm Dubbel (G 340 001)
- **F** 2x Blokkeerpen \varnothing 20-12 L=110 mm (G 520 014)

HULPMIDDELEN



- MB 077 010
Ontkistingsleutel (6,2 kg)

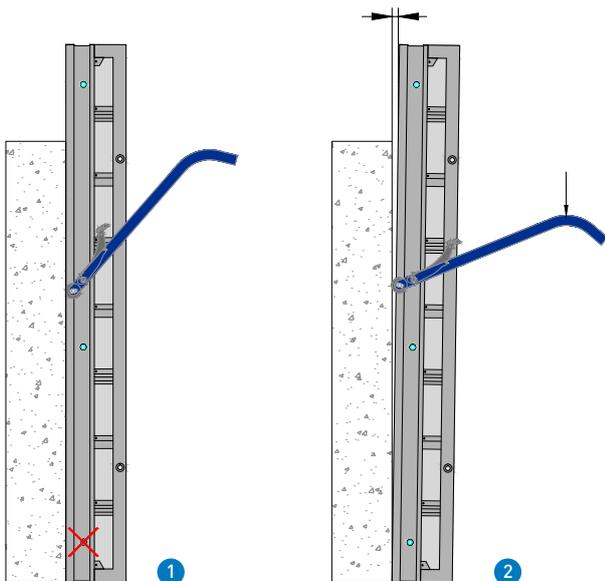

Ontkisten van binnenhoek
Niet met de onderste opening!

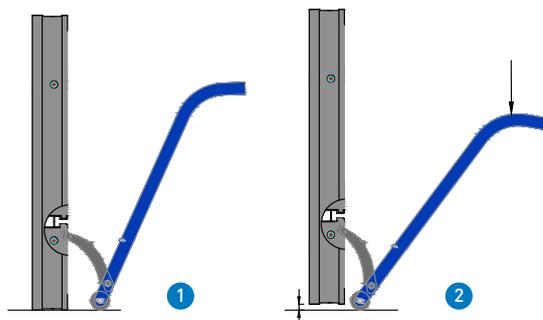

Tillen
om fijn te positioneren



- MB 077 011
Ontkistingspomp (7,4 kg)



- TK 010 001
Materiaalbak Becona
1200x1000x600 (105 kg)

CONSTRUCTIEBALKEN



- **MB 071 040**
Constructiebalk L=400 mm (6,2 kg)
-



vierkantmoer - 15F

- **MB 071 077**
Constructiebalk L=770 mm (10,1 kg)
-



- **MB 071 095**
Constructiebalk L=950 mm (11,9 kg)
 - **MB 071 146**
Constructiebalk L=1460 mm (17,7 kg)
-



- **MB 071 901**
Scharnier-Constructiebalk 950x950 (22,2 kg)
-



- **MB 071 902**
Scharnier-Constructiebalk 1500x1500 (38,5 kg)

STABILISATOREN

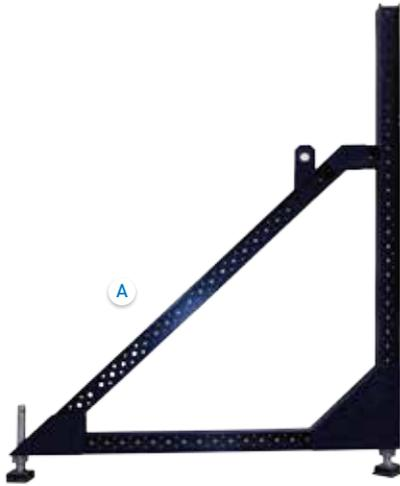

- **MB 078 010** A
Stabilisator Groot (150kg)
- **MB 078 050** B
Stabilisator Klein (130 kg)



• STABILISATOR SET

- **MB 078 001**
Stabilisator Set incl. balken
 - 3x Constructiebalk L=770 mm (MB 071 077)
 - 1x Constructiebalk L=400 mm (MB 071 040)
 - 1x Constructiebalk L=950 mm (MB 071 095)
 - 8x Ankerset (MB 074 001)
 - 5x Vleugelmoer met Oplegplaat 120x120 - 15F (MB 085 613)
 - 3x Centerstaaf L=300 mm - 15F (MB 085 511)
 - 2x Centerstaaf L=800 mm - 15F (MB 085 513)
 - 2x Verbindingsmoer L=105 mm - 15F (MB 085 617)
- **MB 078 002**
Stabilisator Set excl. balken (vlak paneel)
 - 1x Constructiebalk L=400 mm (MB 071 040)
 - 3x Ankerset (MB 074 001)
 - 2x Vleugelmoer met Oplegplaat 120x120 - 15F (MB 085 613)
 - 2x Centerstaaf L=800 mm - 15F (MB 085 513)
 - 2x Verbindingsmoer L=105 mm - 15F (MB 085 617)
- **MB 078 003**
Stabilisator Set excl. balken (Rotondus)
 - 1x Constructiebalk L=400 mm (MB 071 040)
 - 3x Ankerset (MB 074 001)
 - 2x Vleugelmoer met Oplegplaat 120x120 - 15F (MB 085 613)
 - 2x Centerstaaf L=800 mm - 15F (MB 085 513)
 - 2x Verbindingsmoer L=105 mm - 15F (MB 085 617)
- **MB 078 004**
Stabilisator Set Scharnier-Constructiebalk
 - 4x Scharnier-Constructiebalk 1500x1500 (MB 071 902)
 - 16x Ankerset (MB 074 001)
- **MB 078 005**
Stabilisator Set Scharnierhoek
 - 1x Constructiebalk L=400 mm (MB 071 040)
 - 5x Vleugelmoer met Oplegplaat 120x120 - 15F (MB 085 613)
 - 3x Centerstaaf L=300 mm - 15F (MB 085 511)
 - 2x Centerstaaf L=800 mm - 15F (MB 085 513)
 - 2x Verbindingsmoer L=105 mm - 15F (MB 085 617)

TECHNISCHE TEKENINGEN

KOLOMPANEEL 3000X900

Analoog voor breedte 1200

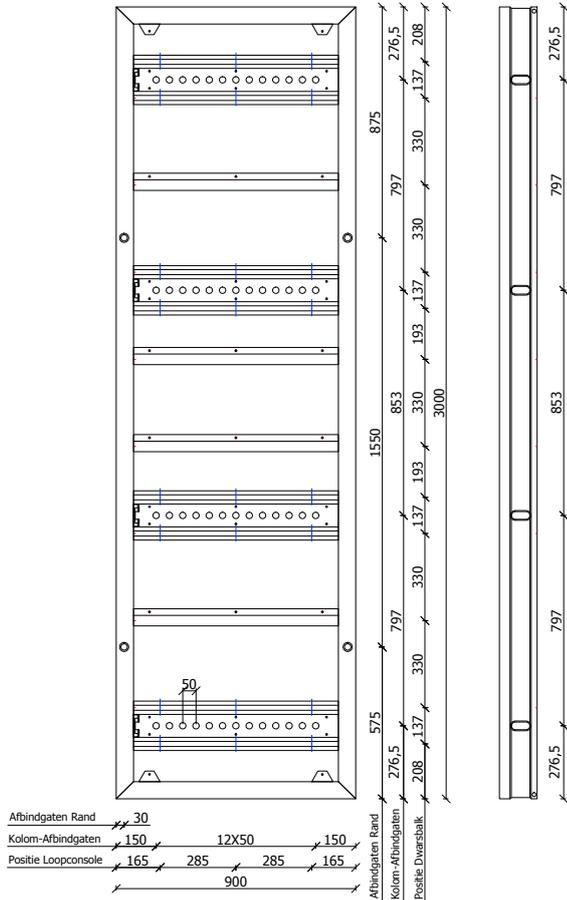

KOLOMPANEEL 2700X900

Analoog voor breedte 1200

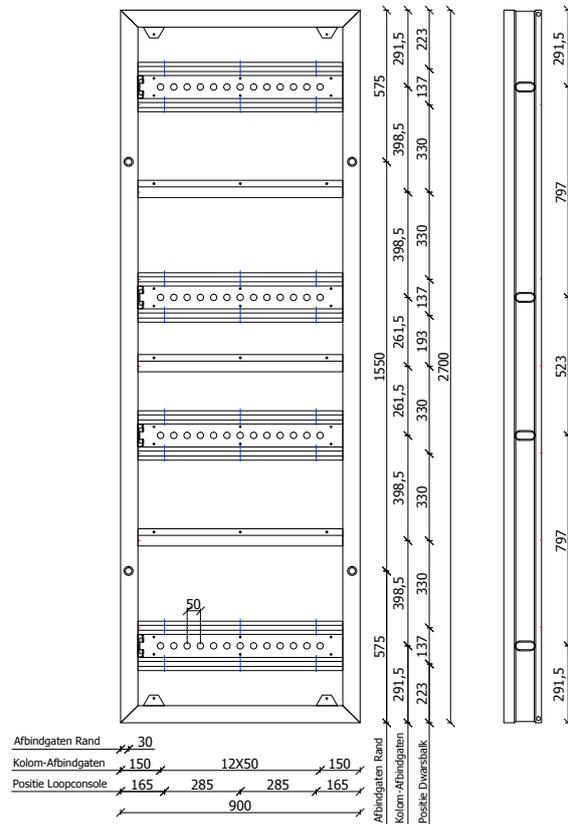

KOLOMPANEEL 1500X900

Analoog voor breedte 1200

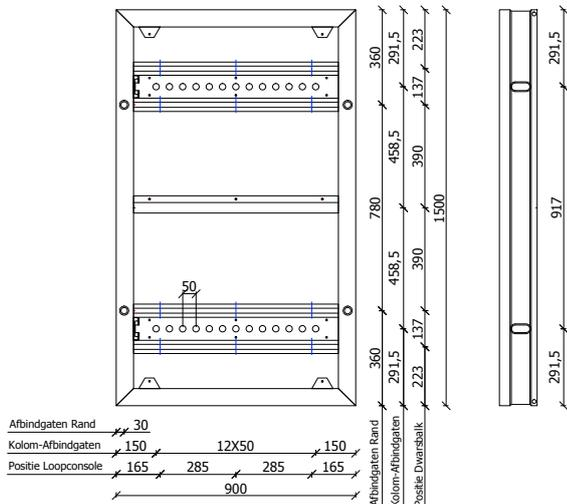

KOLOMPANEEL 1200X900

Analoog voor breedte 1200

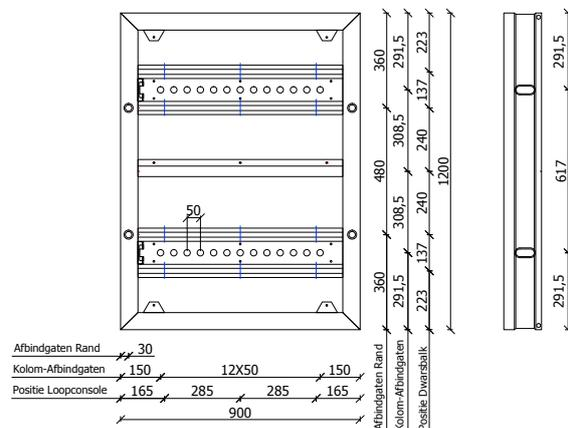

WANDPANEEL 3000X900

Analoog voor breedte 1200-300

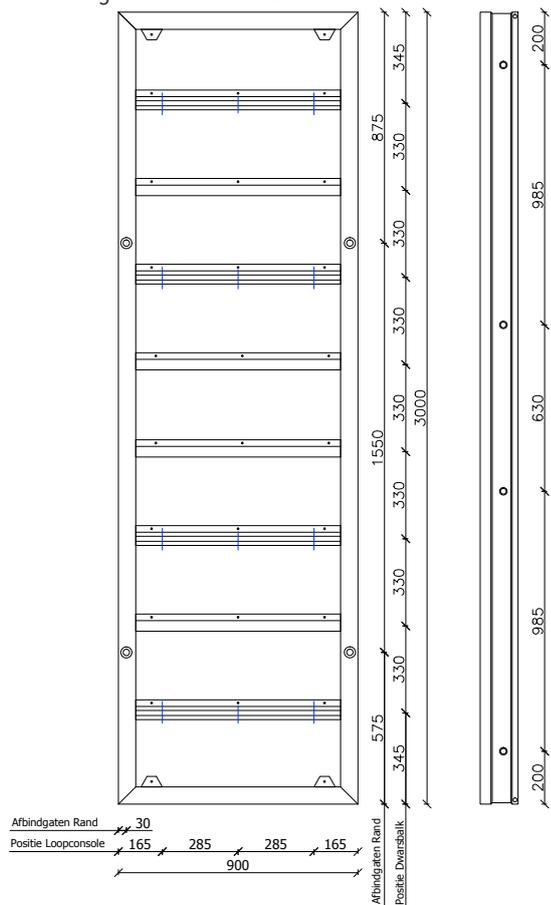

WANDPANEEL 2700X900

Analoog voor breedte 1200-300

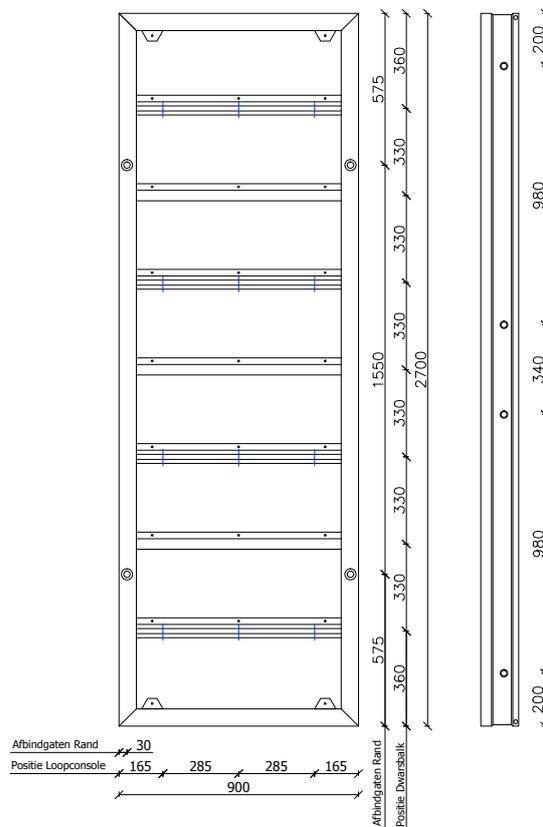

WANDPANEEL 1500X900

Analoog voor breedte 1200-300

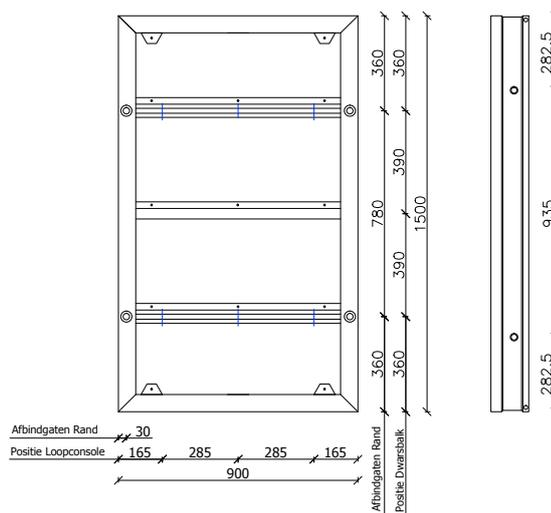

WANDPANEEL 1200X900

Analoog voor breedte 1200-300

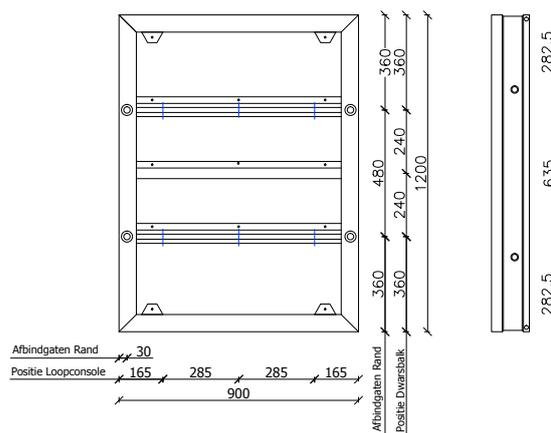

KOPAFSLUITING 3000X505

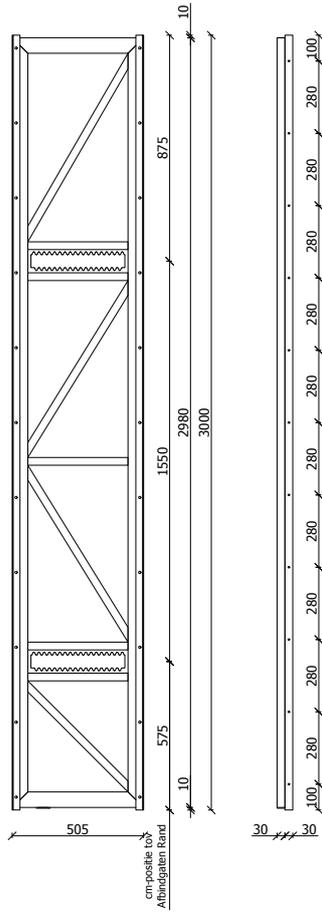

KOPAFSLUITING 2700X505

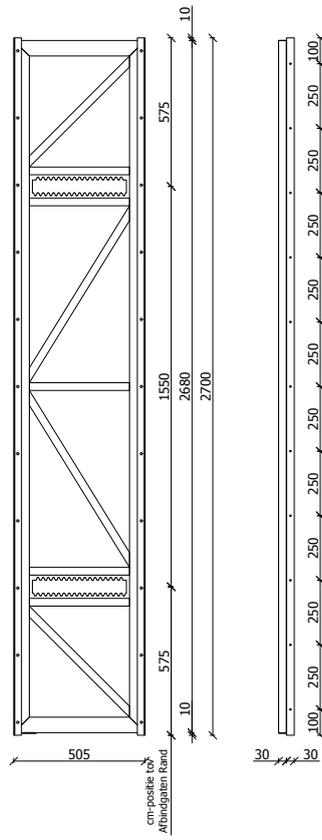

KOPAFSLUITING 1500X505

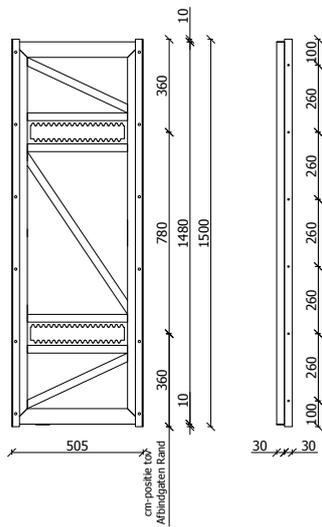

KOPAFSLUITING 1200X505

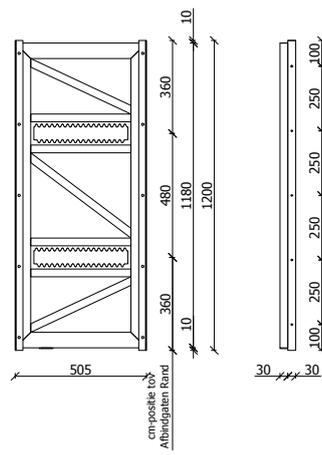

DETAIL VARIABLELE KOPAFSLUITING

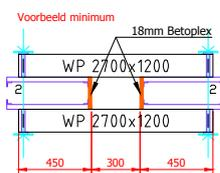
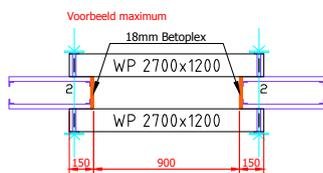

STABILISATOR

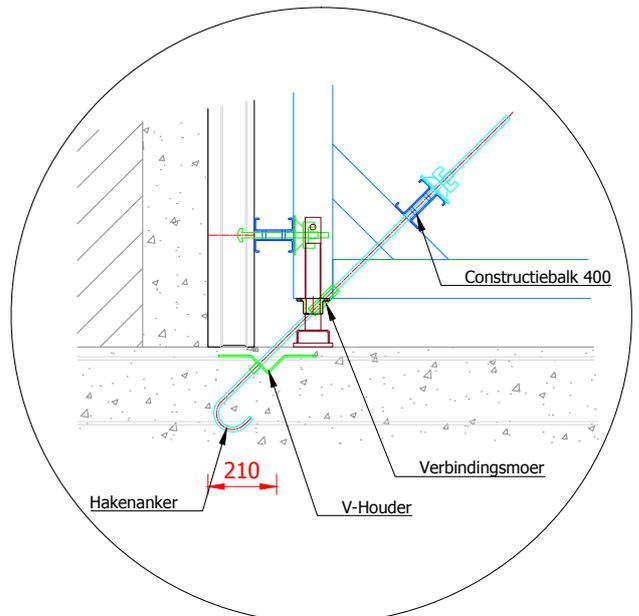
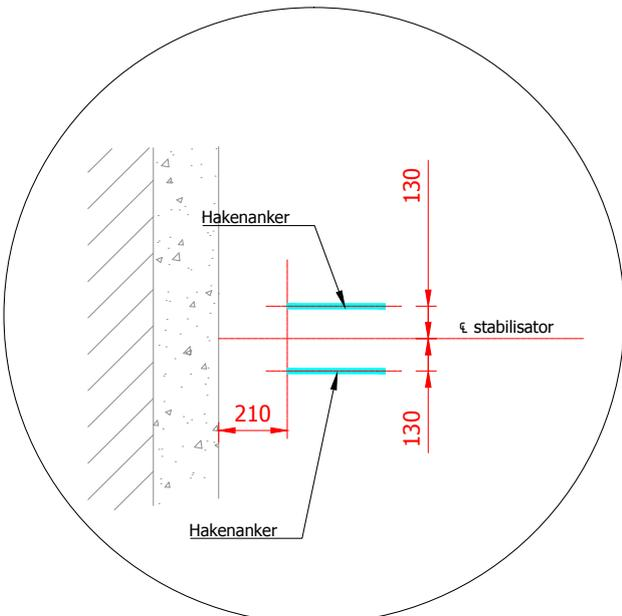
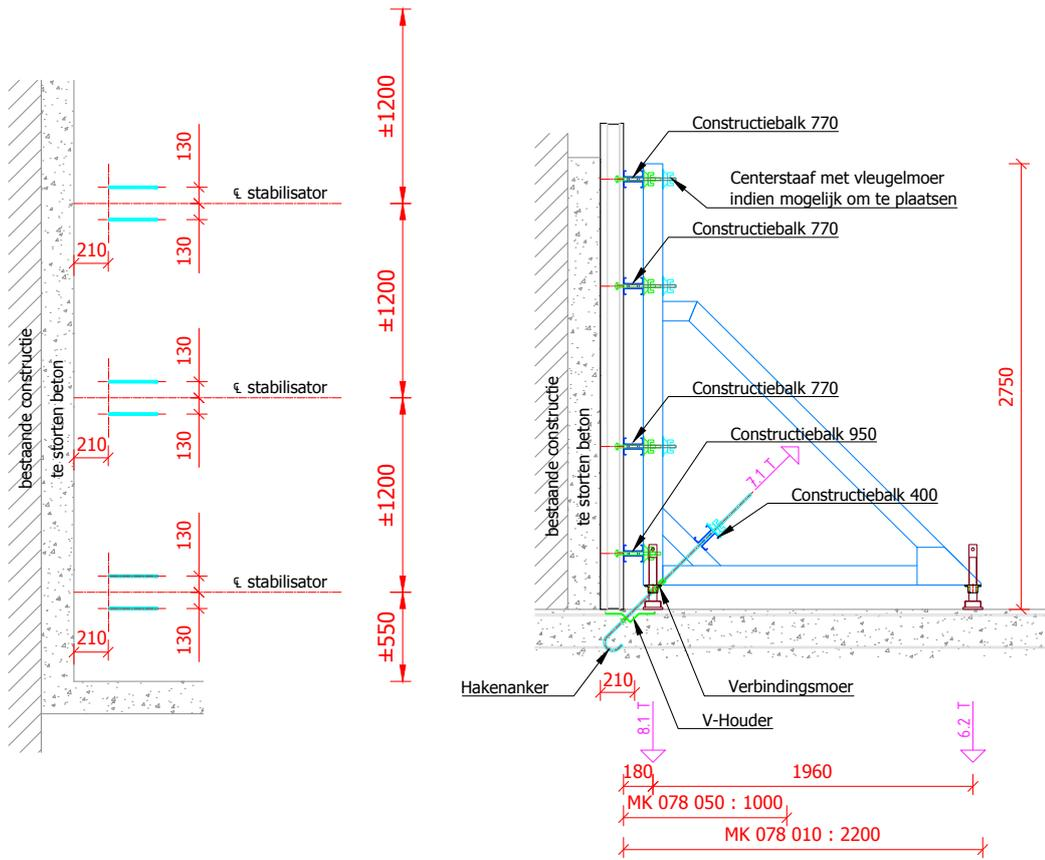

PANEEL 3000

Dubbele Richtschoor 2700-3000 (MB 072 101)

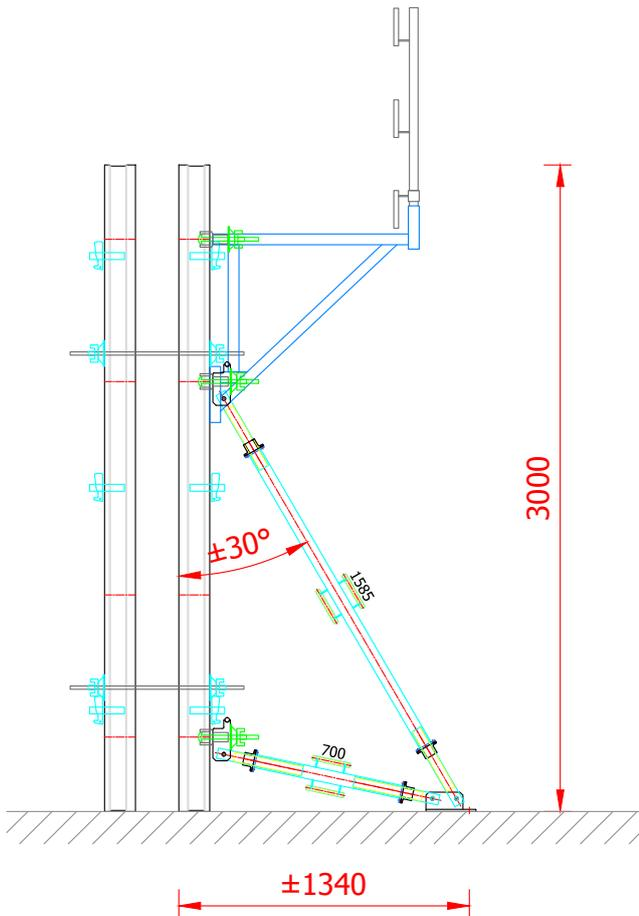

PANEEL 2700

Dubbele Richtschoor 2700-3000 (MB 072 101)

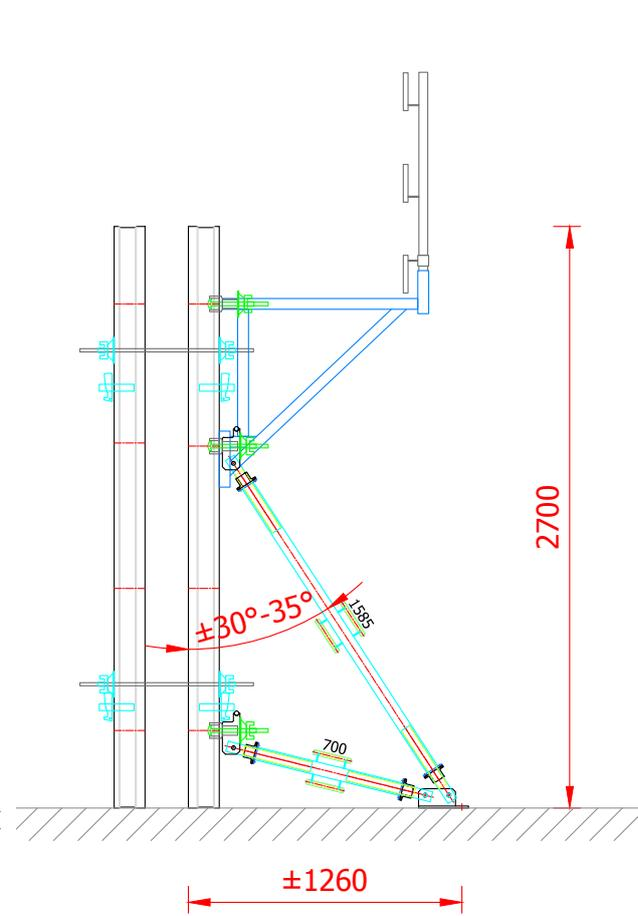

PANEEL 1500 OF 1200

Enkele Richtschoor 1500 (MB 072 103)

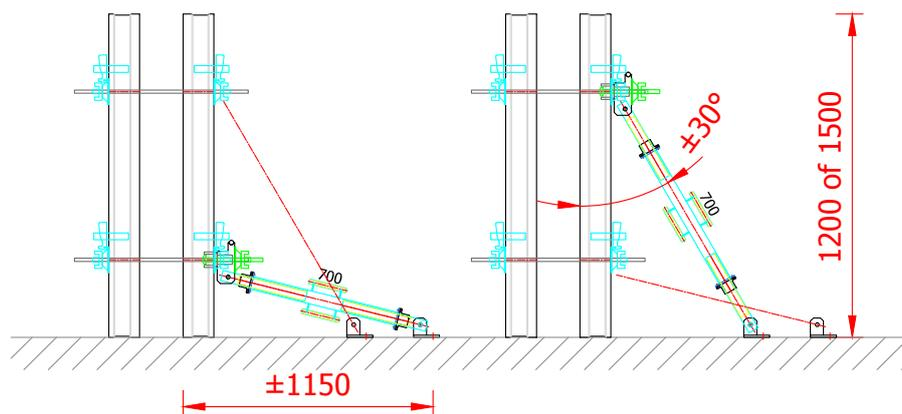

Afwisselend onder en bovenaan schoren

PANEEL 2700 + 1500 OF 1200

Dubbele Richtschoor 2700-3000 (MB 072 101)

Verlengde Enkele Richtschoor (1585-1585) (MB 072 105)

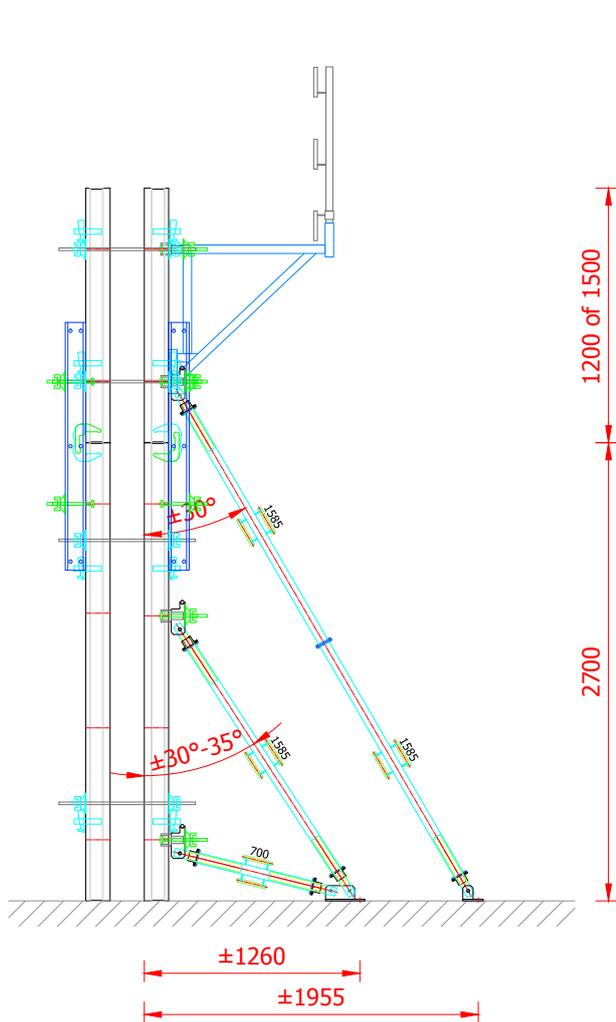

PANEEL 3000 + 1500 OF 1200

Dubbele Richtschoor 2700-3000 (MB 072 101)

Verlengde Enkele Richtschoor (1585-1585) (MB 072 105)

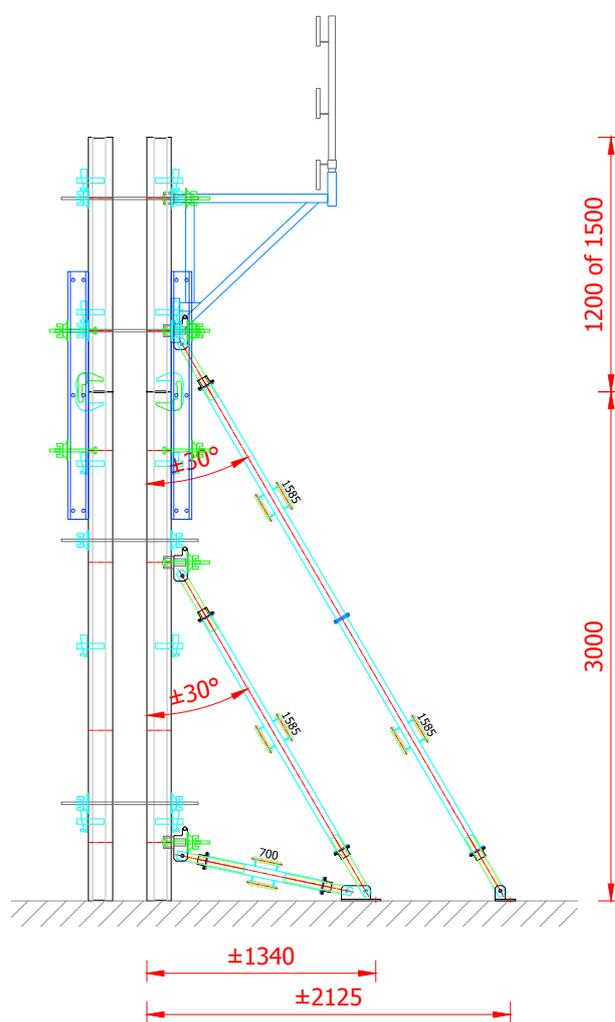

PANEEL 2700 + 2700

Dubbele Richtschoor 2700-3000 (MB 072 101)

Verlengde Enkele Richtschoor +700 (1585-700-1585) (MB 072 106)

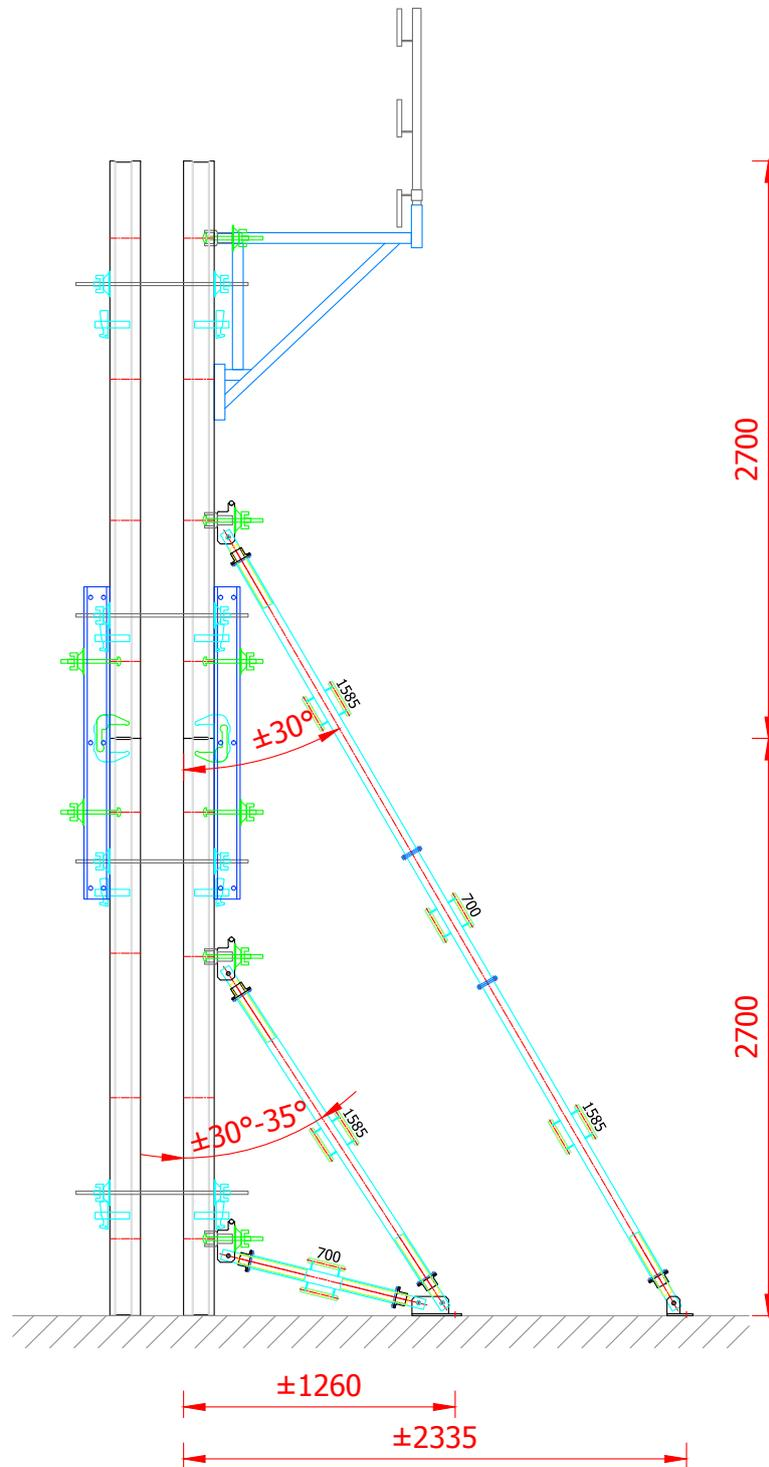

PROJECTEN & MAATWERK









BECONA nv. Industrieterrein 2/6 | I.Z. Webbekom 2022 | 3290 Diest
T. 013-460 160 | F. 013-460 169 | info@becona.be | www.becona.be